

Life Is On

Schneider
Electric

Galaxy VX

Highly efficient, scalable, three-phase power protection with flexible operating modes and EConversion for large facilities, data centers, and business-critical applications.



From 500 to 1500 kW N+1
Parallel solutions up to 4000 kW
380V / 400V / 415V / 440V

schneider-electric.com/ups

Galaxy VX: Scalable, flexible power protection that meets your business objectives

Highly efficient, scalable, three-phase power protection from 500 kW to 1500 kW, with flexible operating modes and ECOConversion, for large facilities, data centers, and industrial applications.

- Flexible operating modes, including ECOConversion™, deliver very high efficiency even at very low load levels
- Four-level inverter technology, increasing UPS reliability and availability
- Flexible energy storage solutions, including support for lithium-ion batteries
- Fully rated system with kVA=kW at 40°C
- Modular, scalable, and redundant configurations, to adapt to real facility needs
- Smart Power Test (SPoT) mode, to test the UPS at the site without the need to rent a load bank before connecting to real load
- Color touch-screen display with a separate mimic diagram

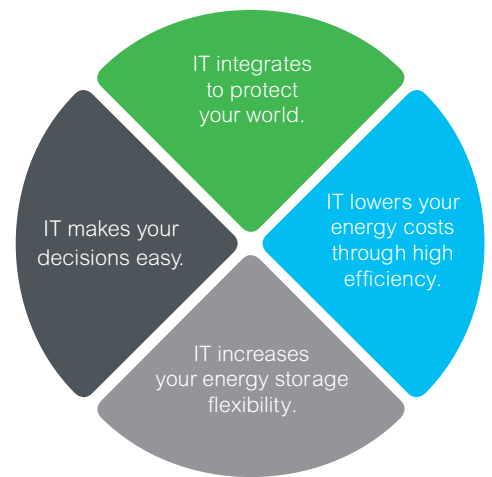

Galaxy VX: Scalable design

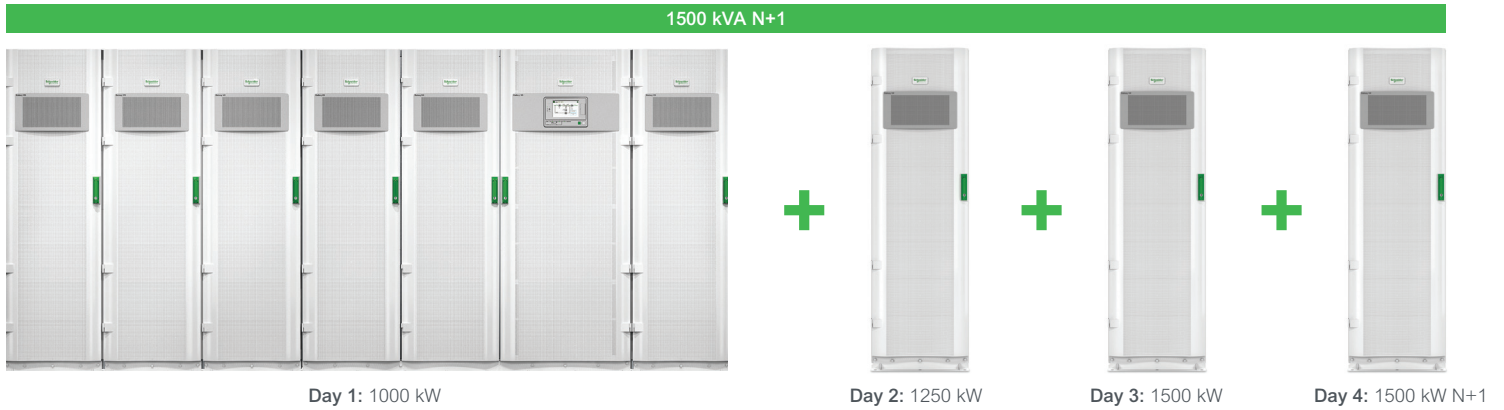

Modular design

The Galaxy™ VX system scales using 250 kW power cabinets. Power cabinets can be added after initial installation to allow for load growth or increased redundancy.

Select your efficiency

Galaxy VX offers three modes of operation. Each mode offers a unique combination of efficiency and performance. Select the mode that best meets your business objectives.

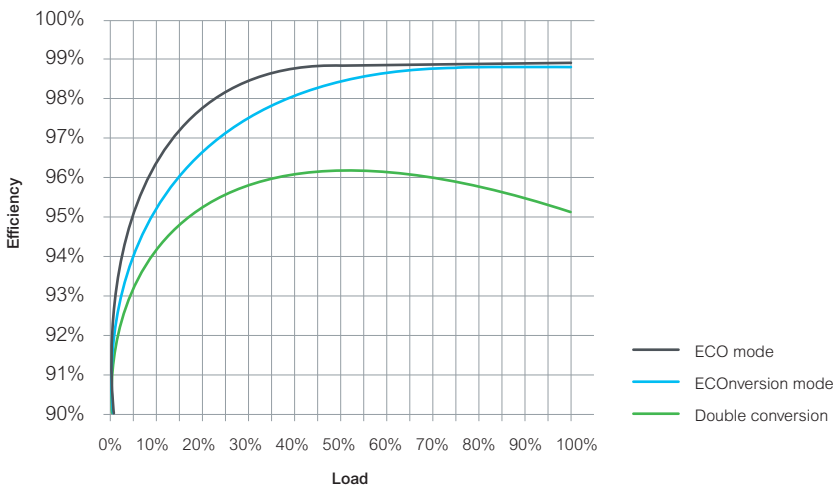
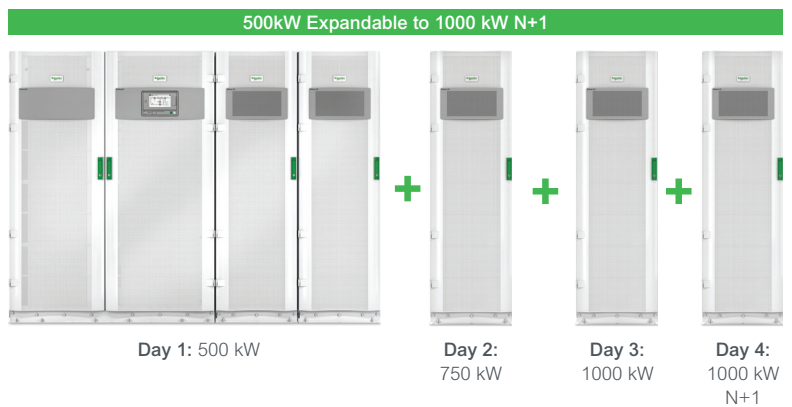

Efficiency curves based on 1000 kW, 415 V UPS data.

Efficiencies are preliminary until validated efficiency data is available.

Reliable, scalable power protection

Galaxy VX redefines how UPS systems meet business objectives. The Galaxy VX's flexibility provides the perfect platform to grow or renew your mission-critical applications. Innovative technologies allow you to select the best match of UPS performance to your business objectives. It offers an adaptable approach to your changing needs. The system can scale or add redundancy after the initial installation. The Galaxy VX supports a wide range of energy storage options, allowing future technologies to integrate into your existing platform.

Galaxy VX:

IT makes your decisions easy

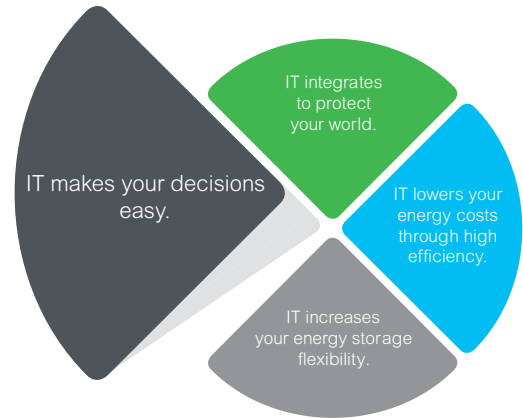

Optimize operational expenses

Your business has unique operational goals, and Galaxy VX meets them with three modes of operation. Choose one or a combination of all three to meet your uptime and power consumption goals:

ECONversion mode

- Ultra high efficiency up to 98.8%
- Keeps excellent load protection
- Programmable for specific day and time periods for better flexibility
- Continuously charges batteries
- Compliant with IEC 62040-3 Class 1 output voltage of UPS standard
- Input power factor correction and low input harmonics
- No-break transfers
- No drop of output voltage, even under low-impedance grid failure

Double conversion mode

- High efficiency in double conversion online mode even at low load levels
- Less energy losses = cost savings
- Less heat dissipation = lower cooling needed, hence cost savings

ECO mode

- Up to 99% efficiency
- Compliant with IEC 62040-3 Class 3 output definition of UPS standard

Manage risk

Stable, protected power is critical to the success of your business. Galaxy VX is designed to meet strict uptime requirements with these design features:

- Innovative four-level inverter reduces losses and component stress, leading to higher efficiency and component reliability
- Configurable internal redundancy provides a fault-tolerant design
- A 110% continuous-duty static switch provides robust overload capabilities
- Modular fault-tolerant power blocks reduce mean time to repair
- SPoT mode allows testing of the UPS without renting a load bank before connecting to a critical load
- Built-in backfeed protection provides human safety and compliance, and saves installation cost

Preserve capital

Your facility needs to grow with your expanding business. Galaxy VX delivers that flexibility along with innovative, cost-saving solutions at every step of the design, installation, and ownership life cycle:

- Pay as you grow — scale system power as load demands increase by adding 250 kW power cabinets after initial installation
- Scale the system for capacity or redundancy
- Fully rated system with kVA=kW at 40°C
- The power factor correction and harmonics filtering at input eliminates oversizing of the upstream infrastructure

Galaxy VX:

IT integrates to protect your world

Integration into your electrical network

- Wide input voltage window and frequency ranges
- Genset compliant with adaptive ramp-in
- Integrated parallel capability with N+1 configurations
- Built-in integrated and tested backfeed protection for human safety and compliance
- Provides input power factor correction and harmonics filtering

Integration into your facility infrastructure

- Compact footprint
- Back-to-back or against-the-wall installation — no rear clearance needed
- Operates at 40°C continuously without de-rating
- Embedded seismic certified to IBC2012 and CBC2013
- Low audible noise levels
- Replaceable dust filter for harsh environments
- Configurable input/output relays
- Top and bottom cable entry
- Parallel capability to increase capacity or redundancy
- External synchronization capability to support synchronized 2N configuration

Smart power test

Ability to test the UPS at full load without the need to rent a load bank before bringing critical load online.

Full integration with Schneider Electric solutions

Fully integrates into the comprehensive Schneider Electric energy management solution for data centers and industrial applications.

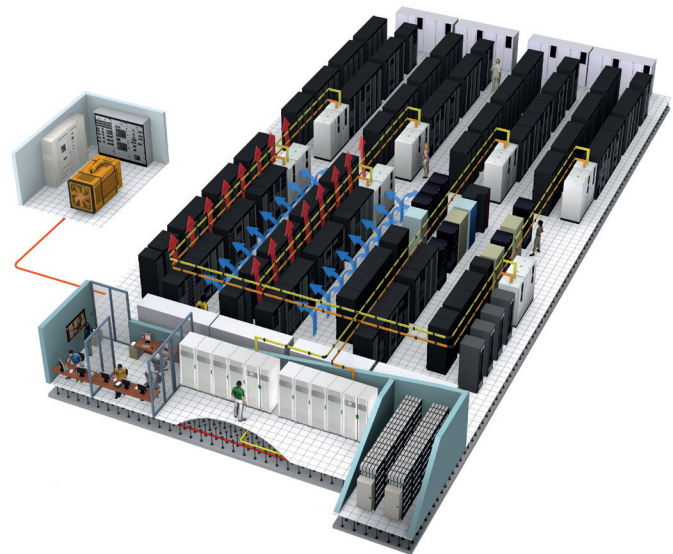
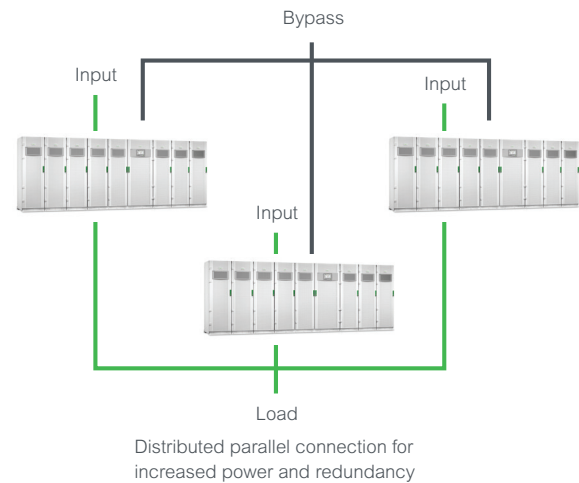
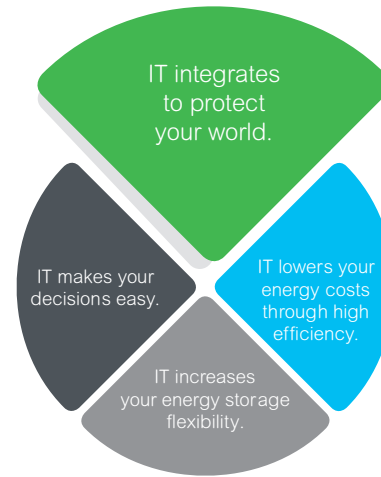

Galaxy VX:

IT lowers your energy costs through high efficiency

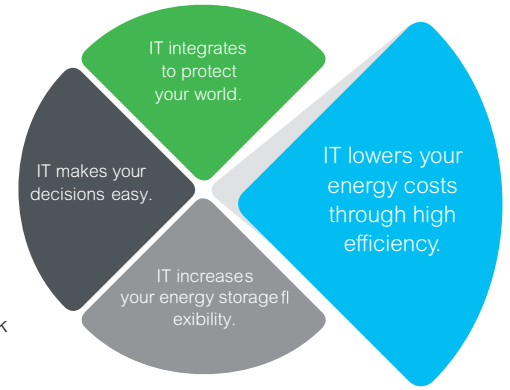

Double Conversion mode

- High efficiency in double conversion online mode even at low load levels

ECO mode

- Up to 99% efficiency
- Compliant with IEC 62040-3 Class 3 output definition of UPS standard

ECONversion mode

Enables control of input current close to the same quality as the on-line UPS with zero-break transfer in the event of a power outage.

- Ultra high efficiency up to 98.8%
- Compliant with IEC 62040-3 Class 1 output voltage of UPS standard

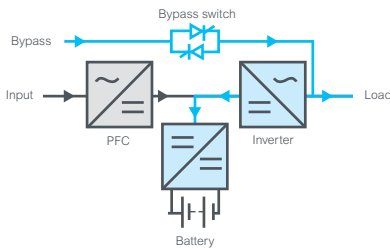

Galaxy VX ECONversion meets Class 1 of IEC 62040-3: Zero-break transfer during power outage

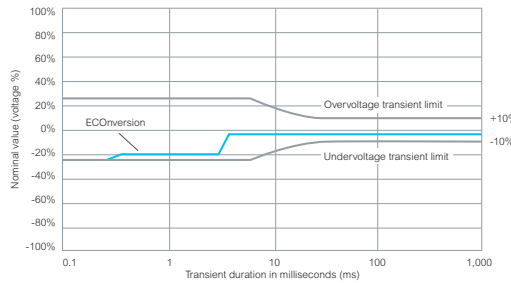

Energy cost savings by using Galaxy VX in ECONversion Mode

	Galaxy VX: high-efficiency double conversion mode	Legacy double conversion UPS	Rotary UPS
Efficiency at 75% load	95.8%	94%	93%
Savings by using Galaxy VX/year (in ECONversion mode)	\$31,500	\$49,600	\$60,800
Ten-year savings by using Galaxy VX (in ECONversion mode)	\$315,000	\$496,000	\$608,000

Considering a total UPS load of 1500 kW with no redundancy.

Calculations assume electricity cost of \$0.13/kWh.

For detailed UPS efficiency comparison, see the Three Phase UPS Efficiency Calculator on schneider-electric.com.

*All figures are estimates. Individual savings could vary.

Software



Cloud-based remote monitoring with EcoStruxure IT Expert – Mobile Insights

EcoStruxure IT Expert – Mobile Insights monitors and protects your critical equipment, providing 24/7 visibility through live data, smart alarming, and data-driven insights on the health of your connected assets directly to your smartphone. Regular reports keep you informed of the status of your unit lifespan and when to plan for battery replacement.



On-premise data center infrastructure management (DCIM)

EcoStruxure IT's on-premise data center infrastructure management suite, StruxureWare™ for Data Centers, is an integrated suite of on-premise applications. It is ideal for businesses that need to manage their data centers across multiple domains. It provides actionable intelligence for an optimal balance of high availability and peak efficiency throughout the entire data center life cycle.

More information

Contact your Schneider Electric representative for more details or visit our website for more information: <https://schneider-electric.com/ecostruxure-it>.

Galaxy VX:

IT increases your energy storage flexibility

Flexible battery protection

DC protection using breakers
Centralized battery protection in a cabinet
Multiple string-by-string battery protection

Flexible energy storage

Compatible with Li-ion , Ni-Cd, Flywheel, VRLA, and wet cells

Flexible charging modes

Ambient temperature charging current adaptation
"GENSET" operation allows the trained user to limit charging current in order to avoid any upstream overload
Temperature fault protection
Different charging methods available

- Floating
- Boost
- Equalization
- Cyclic

Lithium-ion battery cabinet

Rack based concept
3 layers of integrated Battery Monitoring System (BMS)
Both voltage and current monitoring within each cartridge

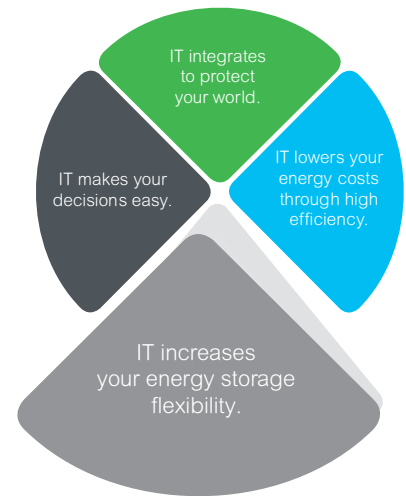

Lithium-ion battery cabinet

Services

A comprehensive portfolio of services

Schneider Electric provides the expertise, services, and support you need for your building, industry, power, or data center infrastructure. Our world-class life cycle services offer a smart way to install and maintain your critical applications, ensuring your systems are always running at peak performance.

Assembly and start-up service by a certified Field Service Representative (FSR) allows full factory warranty coverage. A Schneider Electric-certified installation makes certain your equipment is properly configured for optimal performance. This service features a standard eight hour per day/five day per week response time, with upgrades available for off-business hours.

On-site warranty extension service

In the case of a system event, an FSR will arrive by the next business day (or faster with upgrades) to isolate, diagnose, and correct in as little time as possible, minimizing downtime.

Advantage plans

Flexible service packages offer smooth system maintenance to improve uptime at a predictable cost. The Advantage Plus, Prime, Ultra, and Max are full-service packages that include technical support, preventive maintenance, quick on-site response, and monitoring. Response time upgrades are available.

Preventive maintenance

Preventive maintenance on-site examinations keep your critical systems running at maximum efficiency.

500 kW to 1500 kW UPS

Input parameters				
Rectifier type	IGBT active rectifier			
Input voltage	380 V/400 V/415 V/440 V +20% /-15%, 3PH + PE			
Input connection	Single or dual feed			
Frequency	50 Hz nominal (40 – 70 Hz)			
Input power factor	>0.99			
THDi	<3% @ 100% load			
Walk in	0 to 40 sec (configurable)			
Short circuit withstand rating	100kA			
Output parameters				
Inverter type	4 Level IGBT, high efficiency, transformer-less			
Output voltage	380 V/400 V/415 V/440 V 3PH + N + PE			
Load power factor	0.7 leading to 0.5 lagging without UPS derating			
Output voltage regulation	+/-1%			
Output frequency regulation	50Hz +/- 0.1%			
Overload in normal operation	150% for 60 sec at 40°C			
Overload in bypass operation	110% continuous			
Output power factor	1.0 kVA = kW			
Voltage distortion (THD)	<2% at 100% linear load; <3% at 100% nonlinear load			
DC parameters				
Nominal DC bus voltage	480 VDC			
Energy storage	VRLA, wet cell, Li-ion, flywheel			
Efficiency				
Double conversion mode	Up to 96.4%			
ECONversion mode	Up to 98.8%			
ECO mode	Up to 99%			
Communication				
Control panel	Multifunction touch-screen color LCD display Modbus TCP/IP, SNMP, email, Modbus RS-485 (optional)			
1000kW I/O Cabinet		Physical	1500kW I/O Cabinet	
500 kW UPS (H x W x D)	1970 mm x 2700 mm x 900 mm	1000 kW UPS (H x W x D)	1970 mm x 4400 mm x 900 mm	
750 kW UPS (H x W x D)	1970 mm x 3300 mm x 900 mm	1250 kW UPS (H x W x D)	1970 mm x 5000 mm x 900 mm	
1000 kW UPS (H x W x D)	1970 mm x 3900 mm x 900 mm	1500 kW UPS (H x W x D)	1970 mm x 5600 mm x 900 mm	
Regulatory				
Safety	CE, IEC 62040-1500-1000kW UPS: UL 1778 5th edition, cUL		Seismic	IBC2012
EMC/EMI/RFI	IEC 62040-2		Performance	IEC 62040-3 VFI-SS-111
Protection class			IP20	
Environmental				
Operating temperature	0 to 40°C		Relative Humidity	0 – 95% noncondensing
Operating altitude measurement	1000m		Options	Air filter, relay interface board, system-level factory witness test

Specifications are subject to change without notice. Efficiencies are preliminary until validated efficiency data is available.

132 Fairgrounds Road
West Kingston, RI 02892
USA
Phone: + 800-800-4272
www.schneider-electric.com

Life Is On

Schneider
Electric